

---

Version 1.02

Installation manual  
FISCON Pro  
Hands free kit  
BMW

Article-ID      37663

## Content

General advice .....	1
Safety Instructions .....	2
References of legal regulations for operation .....	2
FISCON Pro BMW .....	3
Scope of delivery .....	3
Installation instruction .....	4
Microphone .....	7
Interface connection .....	8
Control elements .....	10
Operation instruction .....	11
Setup through operation panel .....	15
Operation instruction radio professional (1 DIN) .....	16
Setup through Radio .....	20
FAQ .....	20

## General advice

While developing this product, your personal safety combined with the best operating service, modern design and an up-to-date production technique was especially taken into account.

Unfortunately, despite the utmost care injuries and/or damages might occur due to improper installation and/or use.

Please read the attached instruction manual completely with great care and keep it!

All articles of our production line pass through a 100 % check - for your safety and security.

We reserve the right to carry out technical changes which serve the improvement at any time.

According to each article and purpose, it is sometimes necessary to check each country's legal regulations before installing and starting the unit.

In case of guarantee claims, the device has to be sent back to the seller in the original packaging with the attached bill of purchase and detailed defect's description. Please pay attention to the manufacturer's return

requirements (RMA). The legal warranty directions are valid.

The guarantee claim as well as the operating permission becomes invalid due to: Der Garantieanspruch und auch die Betriebserlaubnis erlischt durch:

- a) unauthorized changes to the device or accessories which have not been approved or carried out by the manufacturer or its partners*
- b) opening the device's frame*
- c) device's repairs carried out by one's own*
- d) improper use / operation*
- e) brute force to the device (drop, wilful damage, accident etc.)*

During installation, please pay attention to all safety relevant and legal directions. The device has only to be installed by trained personnel or similarly qualified people.

## Safety Instructions

Installation requires special knowledge.

Do not install the unit yourself. For safe and reliable installation, consult a dealer having special knowledge.

- *Never use bolts or nuts from the car's safety devices for installation. If bolts or nuts from the steering wheel, brakes or other safety devices are used for installation of the unit, it may cause an accident.*
- *Use the unit with a DC 12V negative ground car. This unit cannot be used in large trucks which use a DC 24V battery. If it is used with a DC 24V battery, it may cause a fire or accident.*
- *Avoid installing the unit in following places: - Where it would hinder your safe driving. - Where it could damage the car's fittings.*
- *This unit is only for use in the following vehicles. Only connections described within this instruction guide are allowed or required to use for installation.*
- *For damage impact caused by faulty installation, unsuitable connections in appropriate vehicles Kufatec GmbH assumes no liability.*
- *We advise you that these units process data out of the MOST - protocol from the vehicle. As the supplier of this device we don't know the overall system you are working with. If our device causes damage due to other changes made by to the vehicle Kufatec GmbH assumes no liability.*
- *Kufatec GmbH supplier do not guaranty the use of the product for changing's within a new vehicle series.*
- *If the car manufacturer's don't agree with the installation of our device by reason of warranty the Kufatec GmbH assumes no liability. Please check conditions and warranty before you begin the installation.*
- *Kufatec GmbH supplier reserves the right to change the device specifications without notice.*

**NOTE:** The road traffic has to have your full attention.

Telephone operations should only be done by suitable traffic and weather situations. The volume need to be set that you are still able to realise acoustic warn signals (Police, fire brigade).

- *Errors and changes excepted.*

## References of legal regulations for operation

Only use this unit in the intended domain.

If you use it in a foreign domain, if the unit is not installed properly, or if the unit will be reconstructed, the guarantee will expire.

## FISCON Pro BMW

- Easy installation, No cutting of wires necessary
- Factory fitted functions do not get affected at all
- **OEM-menu driven** operation by iDrive
- **Display** of telephone information within the central screen
- **Voice output** through the vehicle speakers - no installation of additional speakers necessary
- Use of the following telephone **operations**:
  - Access to the **phonebook, call lists** (depends on mobile phone)
  - **Direct dial** of telephone numbers
  - **A2DP Audiostreaming** in order to transfer music to the Infotainment system of the vehicle – Only for vehicles without factory fitted CD-changer – **A2DP** function has to be activated before using
  - Unlimited software **updates**
  - Volume control

## Scope of delivery

Bluetooth Interface  
Wiring  
Housing  
Microphone

**NOTE:** Before installing the FISCON system you need to check whether the car is retrofitted with an interface not developed by Kufatec GmbH. In case a non-Kufatec interface is fitted we are not able to guaranty the absolute operation of the hands free system. You may need to remove the non-Kufatec interface.

**NOTE: Fiber optical looms MUST NOT BE CRACKED! The recommended radius for fitting is 40 mm.**

In case of incorrect fitting we are not able to guaranty the absolute operation of the hands free system.

**NOTE:**•There is no need to contact the BMW dealer after fitting. The hands free system will be adjusted automatically

## Installation instruction

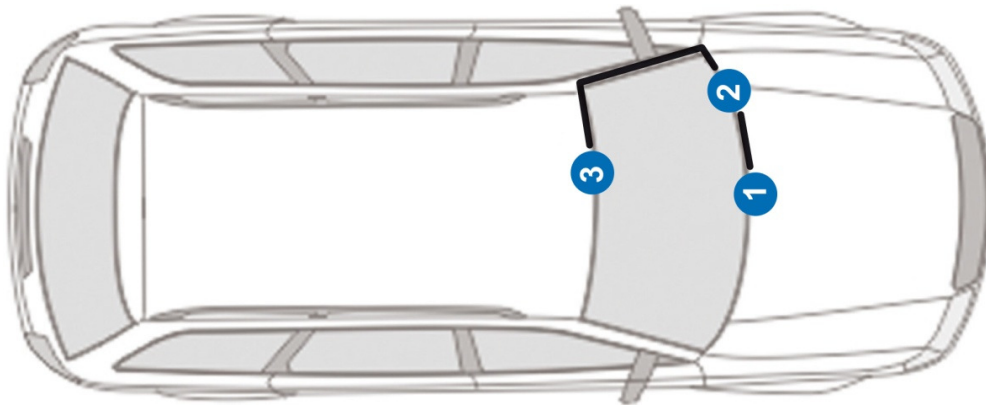

Fig. 1

- 1 – Navigation/ Radio Head unit
- 2 – Telephone interface (Position can be different)
- 3 – Microphone

### 3er - E90, E 91, E92, E93

Remove gently the cover (Fig. 2, 3) by using suitable tools in order to avoid damages. You don't need to remove it completely. Remove the climate control (Fig. 4).



Fig. 2



Fig. 3



Fig. 4

Remove gently the cover of the head unit (Fig. 5). Loosen the necessary screws of the radio (Fig. 6). Remove the head unit.

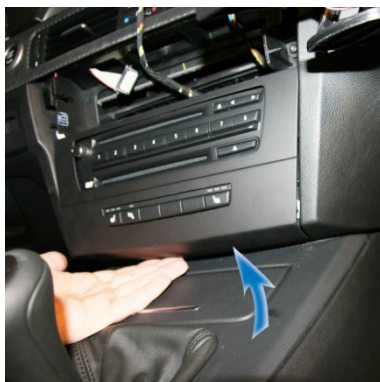

Fig. 5



Fig. 6

## 1er – E81, E82, E87, E88

Remove gently the cover (Fig. 7, 8) by using suitable tools in order to avoid damages.



Fig. 7



Fig. 8

Remove the climate control (Fig. 9). Remove gently the cover of the head unit (Fig. 10). Loosen the necessary screws of the radio (Fig. 11). Remove the head unit.



Fig.9



Fig.10



Fig.11

## 5er – E60, E61

Remove gently the cover (Fig. 12, 13) by using suitable tools in order to avoid damages.



Fig.12



Fig.13

Loosen the screws of the front cover (Fig. 14). Loosen the necessary screws of the radio (Fig. 15). Remove the head unit.



Fig. 14



Fig. 15

Loosen the screws of the cover underneath the glovebox (Fig. 16). Remove the cover of the center console – loosen the screw behind (Fig. 17, 18).



Fig. 16

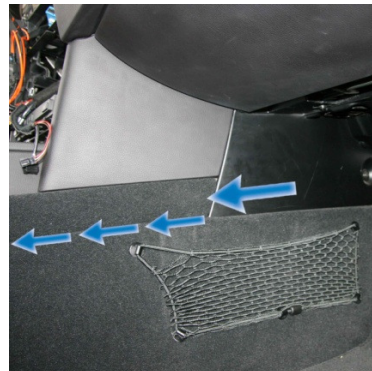

Fig. 17

Remove the rubber of the a-column – mount the telephone interface behind the cover underneath the glovebox. Start wiring the loom of the microphone (Fig. 19).



Fig. 18



Fig. 19

## Microphone

Loosen the necessary screws of the cover underneath the steering wheel as well as the trim aside (Fig. 20). Remove the airbag sign and loose the screw behind (Fig. 21, 22).



Fig.20



Fig.21

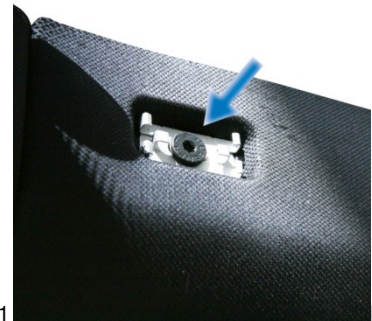

Fig.22

Start wiring the loom for the microphone towards the interior light (Fig. 23). Angle the microphone towards the driver position (Fig. 24).



Fig.23



Fig.24

**NOTE:** Does the vehicle have airbags fitted along the A-column it is essential to wire the loom for the microphone **BEHIND** the airbag. Wire the loom without putting tension on it. Mount the loom without affecting the airbag in its functionality.

**NOTE:** Regarding to the voice quality do not fit the microphone covered inside the interior light.



## Interface connection

Disconnect the Quadlock connector (Fig. 25) of the head unit. Remove the original fiber optical cable (Fig. 26).

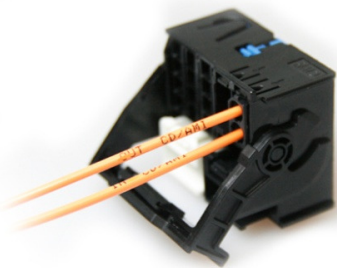

Fig. 25

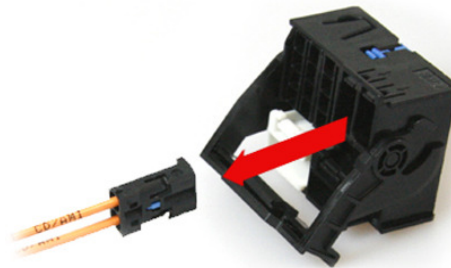

Fig. 26

Put the delivered housing to the just removed (original) fiber optical connector (Fig. 27). Join the original fiber optical connector to the female connector of the delivered loom (Fig. 28-29).

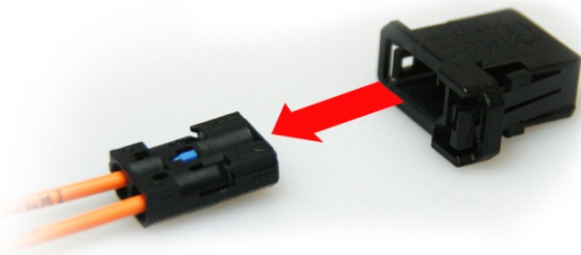

Fig. 27

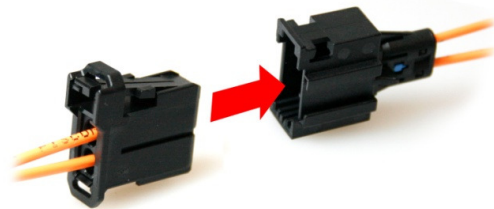

Fig. 28

Put the optical connector of the delivered loom to the Quadlock connector (Fig. 30).

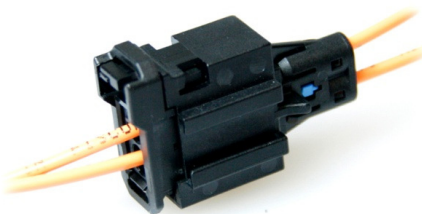

Fig. 29

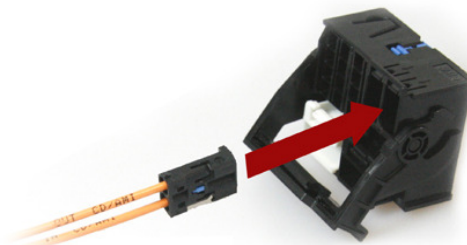

Fig. 30

Join the 18-pole connector as well as the fiber optical to the telephone interface (Fig. 31) (remove dummy plug of the interface). Figure 32 is showing the final connection of the telephone interface.

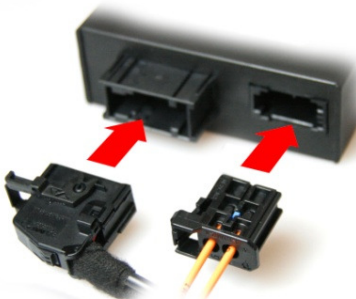

Fig. 31

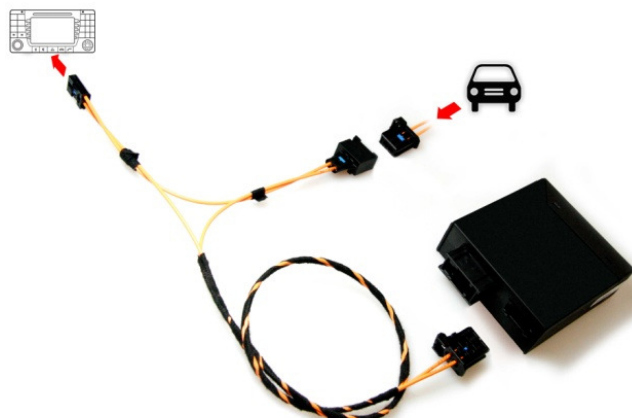

Fig. 32

## Microphone/ Power supply

Connect the female jack of the harness plug & play to the microphone (Fig. 33).

With the connection of 2 new wires you will complete the fitting of the power supply. Please see Fig 34.  
In order to achieve a proper connection we recommend both crimping and soldering the new wires.



Fig. 33

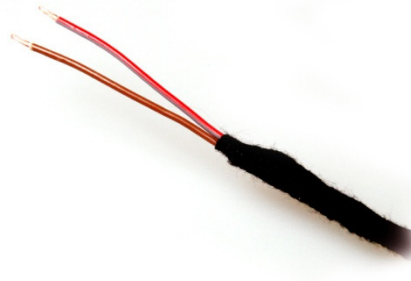

Fig. 34

**BROWN – GROUND**  
**RED – STEADY PLUS**

## Control elements

### Multifunctional steering wheel

By pushing the **TELEPHONE** button you can accept incoming calls (Fig. 36). With the **PLUS - MINUS** buttons you can control the volume.



Fig. 35



Fig. 36

### iDrive Control panel

**OEM-menu driven** operation by using the iDrive operating panel.

After pressing the button **TEL** ① or **MENU** ① the system can be controlled as usual by using the **rotate controller** ②.

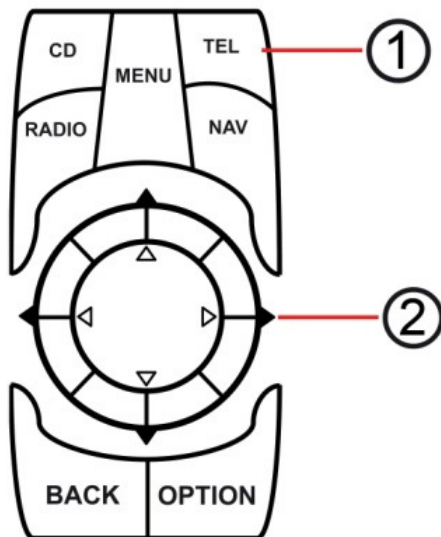

Fig. 37

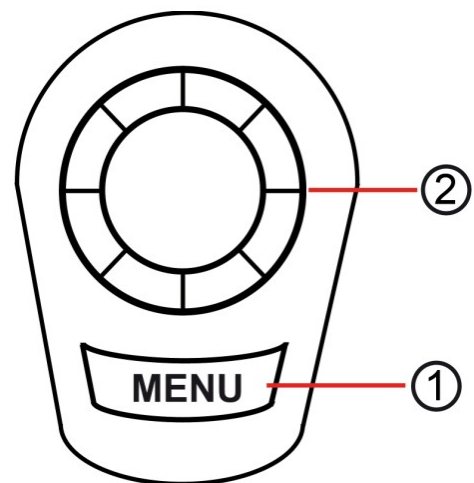

Fig. 38

## Operation instruction

Note - Certain variations can be possible in consequence of original operating.

Once the installation has been finished and the interface is connected the screen will display fig. 39.

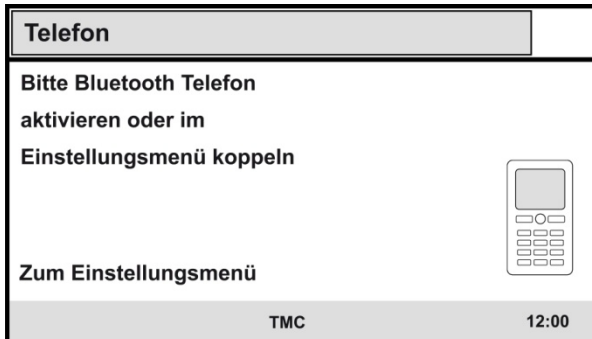

Fig. 39

## Pairing

1. Select the most upper menu level **Communication**
2. Make sure the Bluetooth feature is turned on
3. Start the pairing procedure on your mobile phone
4. Follow the advises of the head unit regarding pairing process
5. When prompted for a passkey, enter **1234** on your mobile phone

Once pairing is complete, you should see Fig. 41. You will see the network provider's name as well as the coverage if supported from mobile phone.

You may pair up to **5** different **mobile phones**.

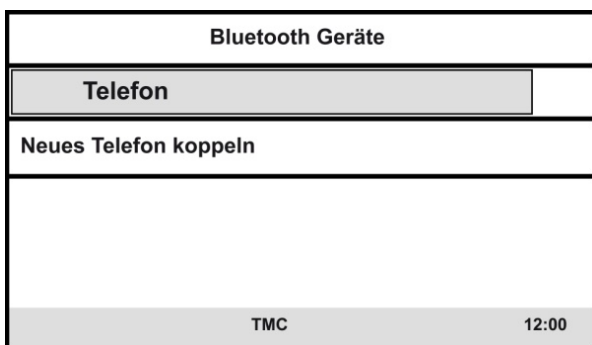

Fig. 40

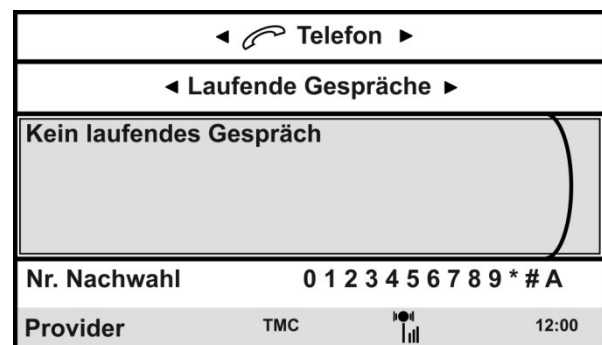

Fig. 41

## Bluetooth device list

You may pair up to **5** different **mobile phones**.

In case of pairing an additional mobile phone (5 mobiles already listed) at least one mobile has to be deleted of the Bluetooth device list.

Through the menu **ALREADY PAIRED PHONES** the single mobile phone can be deleted (Fig. 42-43).

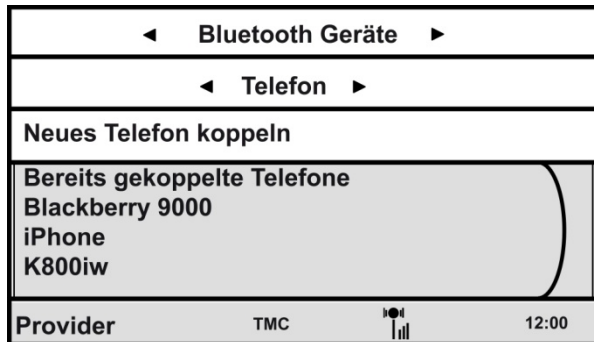

Fig. 42

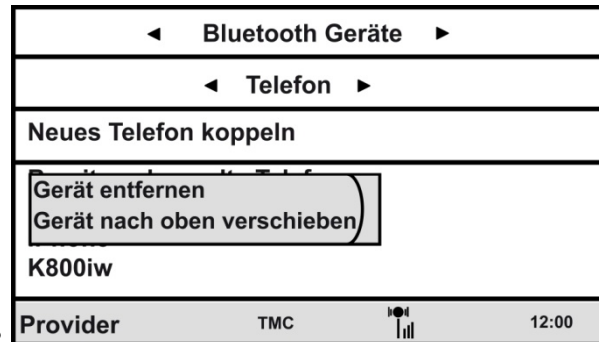

Fig. 43

## Phonebook

**NOTE:** The mobile phone must support phone book sync via Bluetooth to use this feature.  
The phonebook feature is limited to 1000 phonebook entries (sub-entries included).  
Phonebooks that have a large number of entries can take quite a long time to synchronise.  
Please avoid cancelations during synchronisation.

Select the menu **A – Z** (Fig. 44)

Select a phone number for placing a call (Fig. 45).

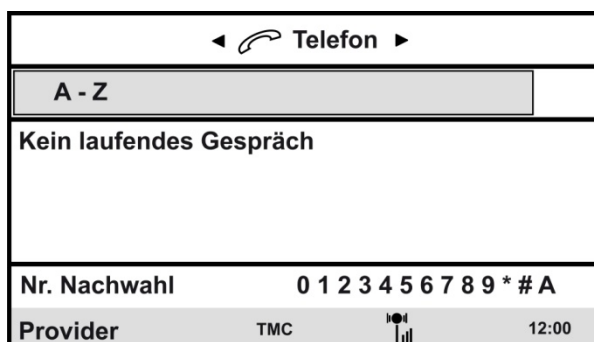

Fig. 44



Fig. 45

## Call lists

**NOTE:** The mobile phone must support call list sync via bluetooth to use this feature.

Select the menu **MISSED CALLS/ RECEIVED/ DIALED**.

Select a phone number for placing a call (Fig. 46).

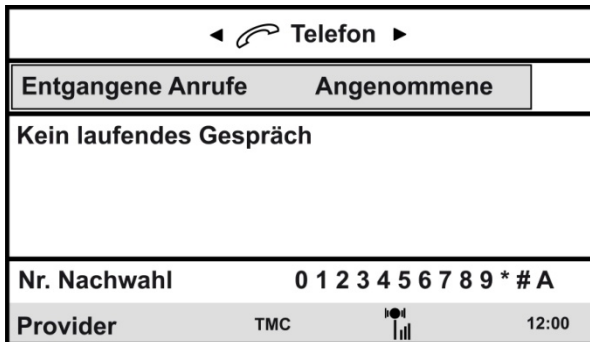

Fig. 46

## Number entry

By using the control panel a telephone number can be entered. Select the menu **DIAL NUMBER**. Enter the number and confirm in order to place a call (Fig. 47).

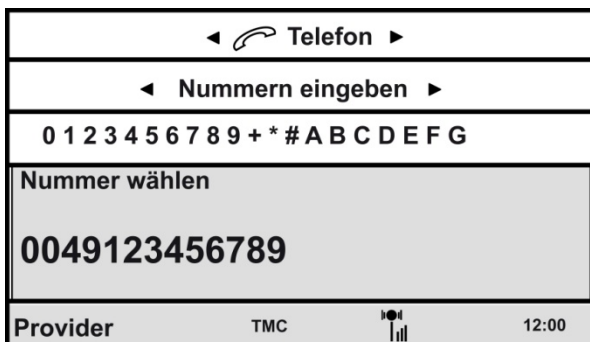

Fig. 47

## Redialing

Select the menu **REDIALING** (Fig. 48). Select an entry and confirm in order to place a call.

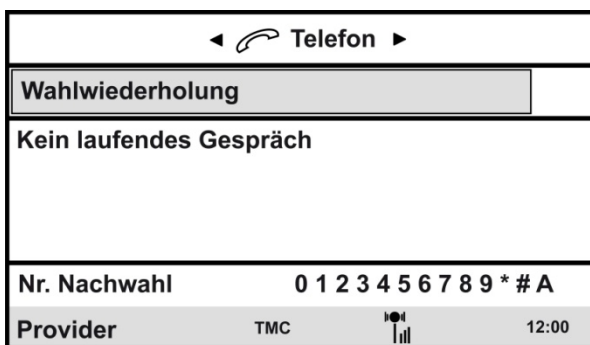

Fig. 48

## Incoming calls

An incoming call will activate the mute operation. A ring tone will be generated. The name of the caller (depends on mobile) will be displayed. In case the caller is not stored by name the number will be displayed.

Select **ANSWER / IGNORE** (Fig. 49).

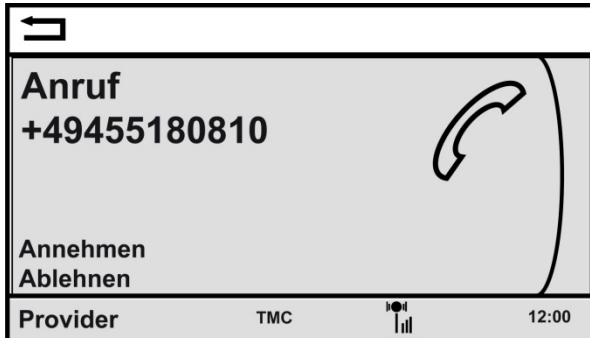

Fig. 49

## A2DP Audiostreaming

**NOTE:** The **A2DP** function has to be **activated** before using.

The mobile phone must support A2DP sync via Bluetooth to use this feature.

Only for vehicles without factory fitted CD-Changer.

## A2DP Activation

Please complete the following steps:

1. Pair up your Bluetooth phone with the hands free as usual
2. Enter the following code: **258224001**
3. After entering the code please press **DIAL** (Fig. 50)

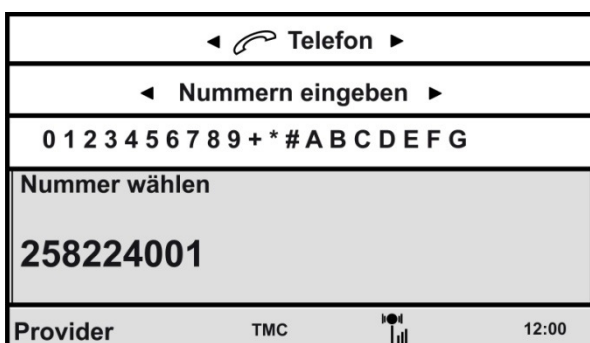

Fig. 50

**NOTE:** The FISCON hands free will complete a reset.

A2DP operation by using the CD-changer menu. Select the menu **ENTERTAINMENT** > **CD** (Fig. 51).

By using **CD 1** the music files stored on the mobile can be selected. (Fig. 52).

- Track 1 – STOP
- Track 2 – FORWARD
- Track 3 – BACK
- Track 4 – START

**NOTE:** The mobile phone must support A2DP sync via Bluetooth to use this feature. In some cases the mobile phone does not support the operation.

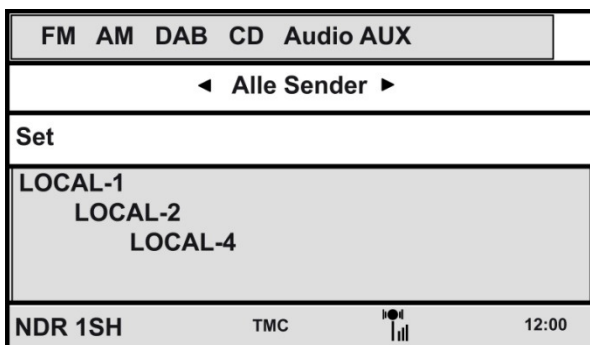

Fig. 51

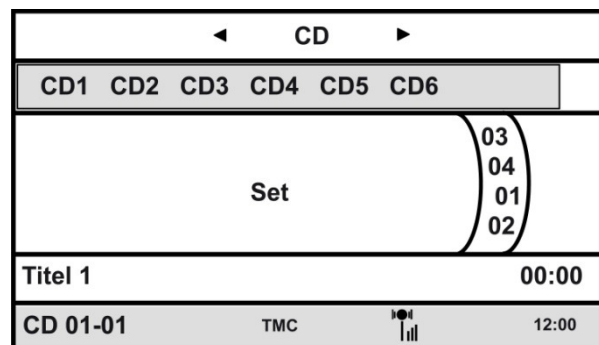

Fig. 52

## Setup through operation panel

### Setup processing

1. Pair up your Bluetooth phone with the hands free as usual
2. Use the following setup - Code: **25822XXYY**
3. Please see the table below for the values **XX** as well as **YY**
4. After entering the code please press **DIAL** (Fig. 53)

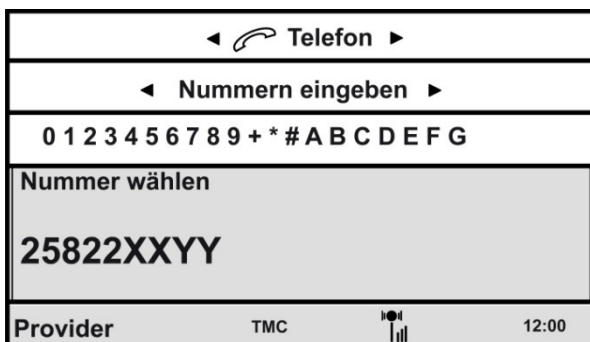

Fig. 53



Function	XX	YY	Example
Volume Telephone	10	(0-15)	258221009
Volume ring tone	11	(0-15)	258221112
A2DP activation	40	01	258224001
A2DP deactivation	40	00	258224000
Microphone adjustment	14	(0-15)	258221409
Hardware Reset	21	77	258222177
Software Update	20	25	258222025

**NOTE:** The FISCON hands free will complete a reset.

## Operation instruction radio professional (1 DIN)

### Pairing

1. Select the button **MENU > TEL**
2. Make sure the Bluetooth feature is turned on
3. Start the pairing procedure on your mobile phone
4. Follow the advises of the head unit regarding pairing process
5. When prompted for a passkey, enter **1234** on your mobile phone

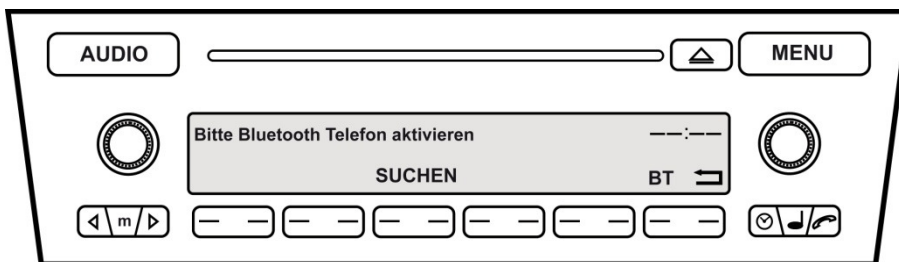

Fig. 54

Once pairing is complete, you should see Fig. 55. You will see the network provider's name as well as the coverage if supported from mobile phone.

You may pair up to **5** different **mobile phones**.

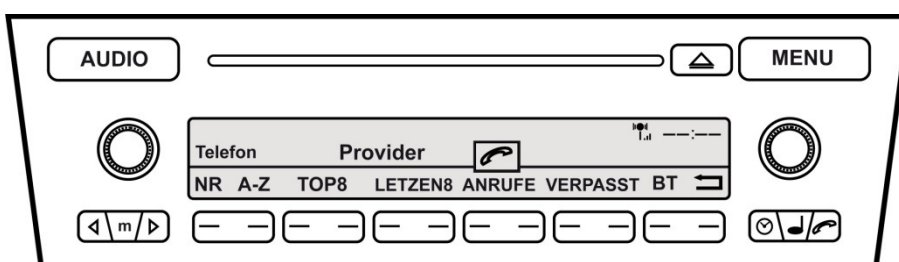

Fig. 55

## Bluetooth device list

You may pair up to **5** different **mobile phones**.

In case of pairing an additional mobile phone (5 mobiles already listed) at least one mobile has to be deleted of the Bluetooth device list.

Through the menu **BT** the already paired mobile phone will be shown (Fig. 56).

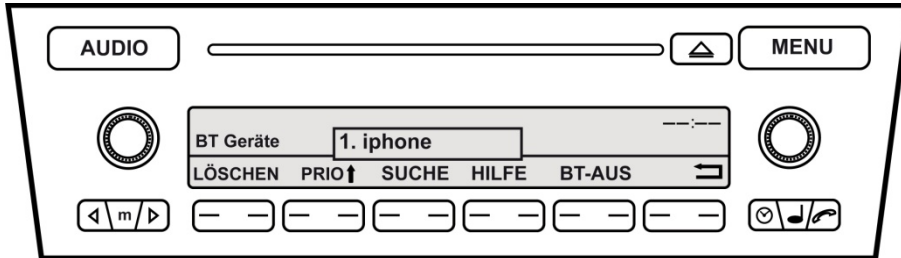

Fig. 56

Each mobile phone can be deleted (Fig. 57).

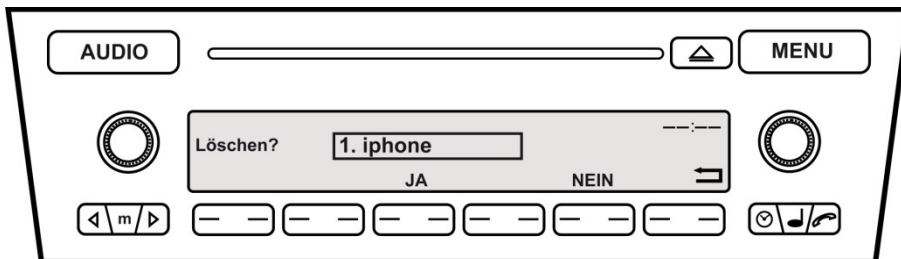

Fig. 57

## Phonebook

**NOTE:** The mobile phone must support phone book sync via Bluetooth to use this feature.

The phonebook feature is limited to 1000 phonebook entries (sub-entries included).

Phonebooks that have a large number of entries can take quite a long time to synchronise.

Please avoid cancelations during synchronisation.

Select the menu **A – Z** (Fig. 58)

Select a phone number for placing a call (Fig. 59).

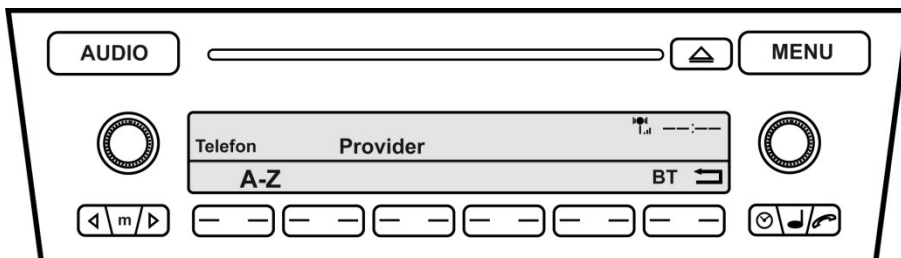

Fig. 58

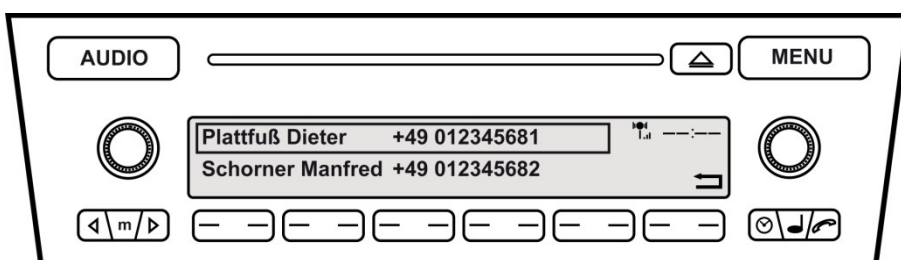

Fig. 59

## Call lists

**NOTE:** The mobile phone must support call list sync via bluetooth to use this feature.

Select the menu **LAST8/ CALLS/ MISSED** (Fig. 60).

Select a phone number for placing a call.

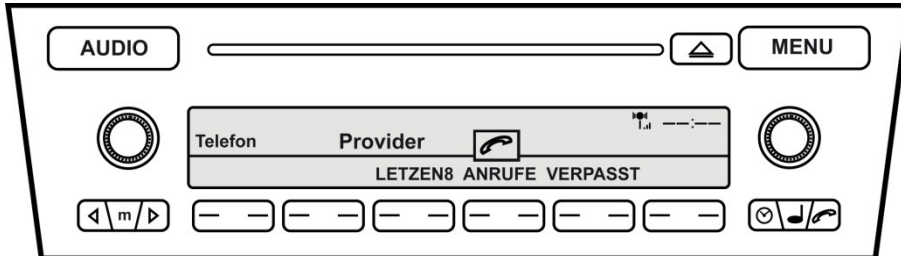

Fig. 60

## Number entry

Select the menu **NR.**

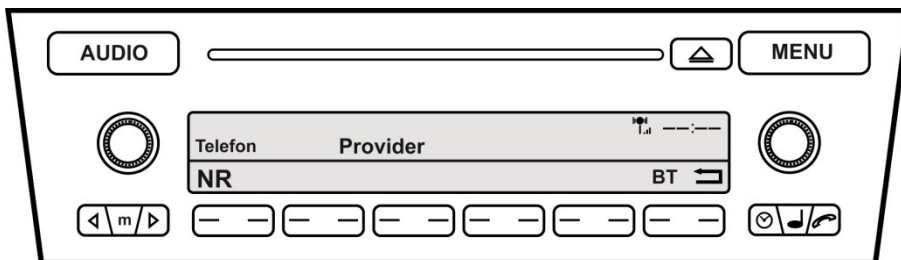

Fig. 61

Enter a number and confirm for placing a call (Fig. 62).

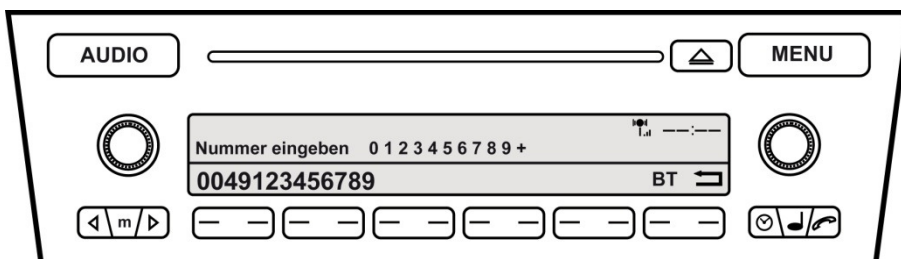

Fig. 62

## A2DP Audiostreaming

**NOTE:** The **A2DP** function has to be **activated** before using.  
The mobile phone must support A2DP sync via Bluetooth to use this feature.  
Only for vehicles without factory fitted CD-Changer.

### A2DP activation

Please complete the following steps:

1. Pair up your Bluetooth phone with the hands free as usual
2. Select the menu **NR**
3. Enter the following code: **258224001**
4. After entering the code please press **DIAL** (Fig. 63)

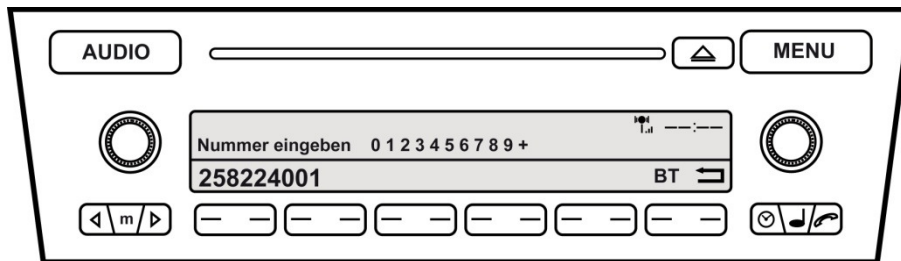

Fig. 63

**NOTE:** The FISCON hands free will complete a reset.

A2DP operation by using the CD-changer menu. Select the menu **CD**.

By using **CD 1** the music files stored on the mobile can be selected. (Fig. 64).

- Track 1 – STOP
- Track 2 – FORWARD
- Track 3 – BACK
- Track 4 – START

**NOTE:** The mobile phone must support A2DP sync via Bluetooth to use this feature. In some cases the mobile phone does not support the operation.

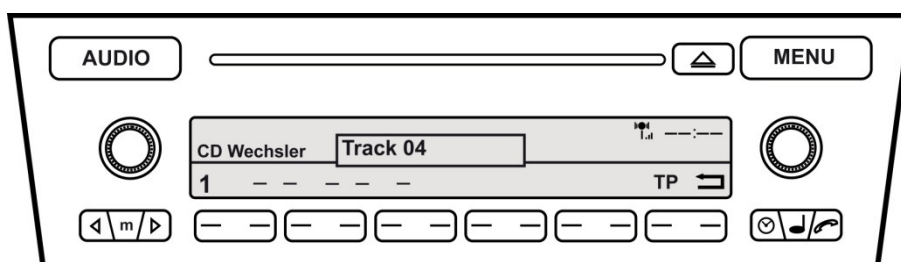

Fig. 64

## Setup through Radio

### Setup processing

1. Pair up your Bluetooth phone with the hands free as usual
2. Use the following setup - Code: **25822XXYY**
3. Please see the table below for the values **XX** as well as **YY**
4. After entering the code please press **DIAL**

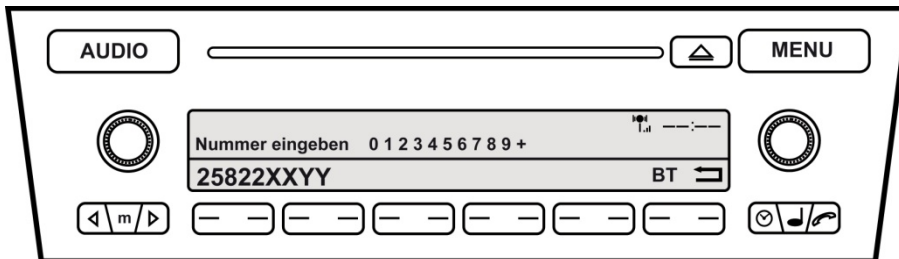

Fig. 65

Function	XX	YY	Example
Volume Telephone	10	(0-15)	258221009
Volume ring tone	11	(0-15)	258221112
A2DP activation	40	01	258224001
A2DP deactivation	40	00	258224000
Microphone adjustment	14	(0-15)	258221409
Hardware Reset	21	77	258222177
Software Update	20	25	258222025

**NOTE:** The FISCON hands free will complete a reset.

## FAQ

Why does the phonebook not pop up in the screen?

- Your Bluetooth phone doesn't support phonebook sync.
- Phonebooks that have a large number of entries can take quite a long time to synchronise.

I'm not able to pair my Bluetooth phone.

- You already paired up 5 different mobile phones. At least one mobile has to be deleted of the Bluetooth device list

I'm not able to use A2DP

- A2DP function has to be activated before using.
- Your Bluetooth phone doesn't support A2DP

## FAQ – Online

<http://www.kufatec.de/faq/public.pl?Action=PublicFAQ&Subaction=Explorer&CategoryID=1>